

4

3

2

1

DWG NO. HD-148 SH 1 REV -

REVISIONS				
ZONE	REV	DESCRIPTION	DATE	APP

- SUPPLY VOLTAGE: 6V TO 30V DC REGULATED
- SUPPLY CURRENT: 20mA MAX @ NO LOAD
- OUTPUT TYPE: PUSH/PULL, DIFFERENTIAL, TTL/CMOS (5V)
- OUTPUT SATURATION VOLTAGE HIGH: 0.6V MAX @ 30mA
- OUTPUT SATURATION VOLTAGE LOW: 0.4V MAX @ -30mA
- PROTECTION: REVERSE POLARITY AND OUTPUT SHORT CIRCUIT
- OPERATING FREQUENCY: 0Hz TO 15kHz
- AIR GAP: 0.100" (SEE NOTE 1)
- DUTY CYCLE: 50% ± 25% DEPENDENT ON TARGET GEOMETRY
- PHASE SHIFT: 90° ± 45° DEPENDENT ON TARGET GEOMETRY (SEE ALIGNMENT)
- ALIGNMENT: 12P (2M) SPUR GEAR CONTACT FACTORY FOR CUSTOM ALIGNMENT
- OPERATING TEMPERATURE: -40°C TO 125°C
- STORAGE TEMPERATURE: -40°C TO 125°C
- MATING CONNECTOR: MIL-DTL-26482 TYPE 10-6SN
- ENVIRONMENT RATING: IP68

DIRECTION A

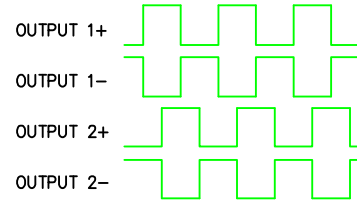

DIRECTION B

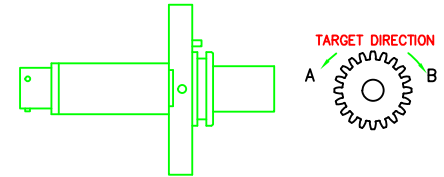
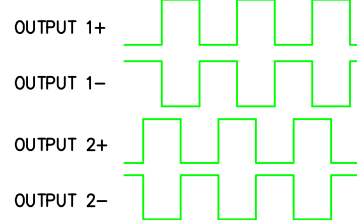

GEAR DIRECTION	OUTPUT 1	OUTPUT 2
DIRECTION A	LEAD	LAG
DIRECTION B	LAG	LEAD

NOTES:

1. AIR GAP IS DEPENDENT ON TARGET GEOMETRY AND OPERATING FREQUENCY. HIGHER OPERATING FREQUENCIES AND FINER PITCH GEARS MAY REQUIRE AIR GAPS LESS THAN 0.100"

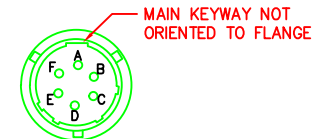
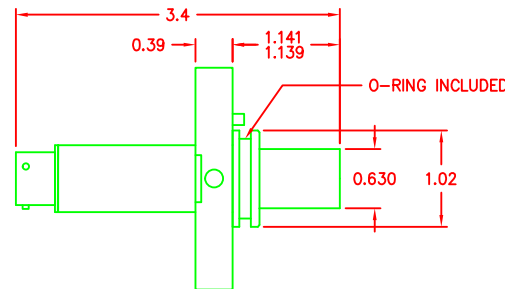
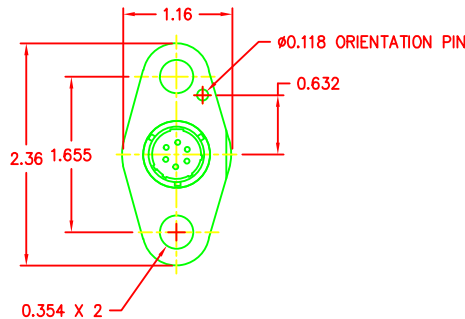

PIN DESCRIPTION	PIN
POWER INPUT	A
POWER AND PULSE COMMON	B
OUTPUT PULSE 1+	C
OUTPUT PULSE 2+	D
OUTPUT PULSE 1-	E
OUTPUT PULSE 2-	F

 <p><b>MOTION SENSORS</b> SPEED SENSING SOLUTIONS</p>	MATERIAL	300 SERIES STAINLESS	APPROVALS	DRAWN W. STAMBAUGH DATE 08/24/16 CHECK M. PRITCHARD 08/24/16 ISSUED M. PRITCHARD 08/24/16	<b>MOTION SENSORS, INC.</b> TITLE OUTLINE-SPECIFICATION DRAWING DUAL HALL EFFECT, PUSH/PULL TYPE DIFFERENTIAL TTL/CMOS (5V) OUTPUT, FLANGED HOUSING WITH CONNECTOR
	FINISH		UNLESS OTHERWISE SPECIFIED DIMENSIONS ARE IN INCHES. TOLERANCES OTHER THAN THE SIZE OF RAW MATERIAL SHALL BE HELD AS FOLLOWS: 1 PLACE DECIMAL ±.1 2 PLACE DECIMAL ±.01 3 PLACE DECIMAL ±.005 FRACTIONAL ±1/64 ANGULAR ±1/2°		
786 PITTS CHAPEL ROAD ELIZABETH CITY, NC 27909	CONFIDENTIAL PROPERTY OF MOTION SENSORS, INC. (MSI) NOT TO BE DISCLOSED TO OTHERS, REPRODUCED, OR USED FOR ANY OTHER PURPOSE, EXCEPT AS AUTHORIZED IN WRITING BY MSI. MUST BE RETURNED ON DEMAND.		SIZE C CAGE CODE OY2U4 SCALE NONE	DWG NO HD-148 REV - SHEET	

4

3

2

1